



Sika Technology and Concepts for Adhered Roofing Systems with Single Ply Membranes



Innovation & Consistency | since 1910





Sika Technology and Concepts for Adhered Roofing

As a leading worldwide materials manufacturer for the construction industry, Sika has a strong focus on roofing and produces a wide range of different products and systems to meet our customers' requirements and conform to the latest standards. This brochure illustrates the application field and technicalities of adhered roofing. It will aid the customer to find the right Sika adhered roofing system to fit his project requirements and will give him an overview of the available solutions.

We are present locally in more than 70 countries, which allows us to bring our customers and their clients not only proven roofing products, but additional services, such as wind load calculations, application trainings, CAD details and technical consultations or guarantees. Sika is the only full range materials supplier for concrete production, waterproofing, roofing, flooring, sealing, bonding, grouting, reinforcing, concrete repair and protection, structural glazing and more, for all types of buildings and civil engineer structures. This makes us the most complete and competent partner for the new construction or refurbishment of your projects.

We hope that this brochure will give you an overview of Sika's solutions for adhered roofing.

For further information, advice or assistance, please contact your local Sika Company or go to www.sika.com.

Content

The Principles of Adhered Roofing	4
Sika Adhered Roofing Experience	6
Solutions for Adhered Roofs: New Constructions	8
Solutions for Adhered Roofs: Refurbishment of Bitumen Roofs	10
Membrane and Adhesive Competence of Sika	12
Sika Adhered Roofing Product and Application Overview	14
Installing Adhered Roofs	16
Ancillary Materials and Accessories	18
Services and Support in Roofing	20
Sika Roofing Capabilities – Factory House	22
Sika Adhered Roofs: Case Studies	24
Performance and Installation Related Requirements	26

The Principles of Adhered Roofing



General Description

Adhesive attachment of the exposed **Sikaplan**® or **Sarnafil**® roofing membrane is an option for nearly any roof. These systems are suitable for a very wide range of slopes and geometries as well as new constructions and refurbishment projects. By bonding the membrane, the adhered roofing systems offer many benefits.

- High aesthetical performance
- Unlimited design possibilities
- No visible fixings
- No membrane movement
- Ideal for simple to complex and demanding roof shapes
- For new constructions and roof refurbishments

Individual Design Possibilities

Sikaplan® and **Sarnafil**® single ply membranes offer virtually unlimited opportunities in roof design. The flexible membranes take on the shape of any roof – even the most complex forms. Adhered roofing systems are especially versatile and are equally suitable for contemporary and traditional designs.

- Traditional flat roofs
- Curved roofs
- Sloped and pitched roofs

The adhered roof satisfies the toughest aesthetical requirements and offers maximum design freedom. The **Sikaplan**® and **Sarnafil**® product lines offer additional design possibilities for adhered roofs.

- Range of colours
- Décor and Batten profiles
- Roof Graphics

Installation Principles

The **Sikaplan**® and **Sarnafil**® single ply roofing membranes are attached to the thermal insulation or roof deck by using either an on-site applied liquid adhesive or with a factory-manufactured adhesive backing on the membranes. The application methods are split into three main groups.

- Fully adhered membranes
- Partially adhered membranes
- Self adhered membranes

Sika adhered roofing systems with single ply membranes are suitable for most building types and have many advantages for the applicator and building owner.

- No penetrations of the roof deck
- Low noise emissions during installation
- Cold applied membrane – no flame, no heat
- Easy refurbishment of existing bitumen roofs



Fully Adhered Membranes

In the **Sarnafil**® fully adhered systems the membrane is adhered to the full surface of the substrate. This application is perfect for small to medium sized roofs. Key benefits are:

- Superior aesthetics
- Suitable on simple and complex roof shapes

The **Sarnafil**® **G** (PVC) and **Sarnafil**® **T** (FPO) membranes as well as a range of adhesives and accessories are specially designed for the fully adhered application.

Partially Adhered Membranes

In the **Sikaplan**® partially adhered system the membrane adhesive is applied to the substrate in strips. This makes it an economical choice of adhered roofing.

- Low adhesive consumption
- Suitable for large industrial roofs where no penetrations are wished

The **Sikaplan**® partially adhered system offers a lean product range, designed to suit most projects.

Self Adhered Membranes

The **Sikaplan**® self adhered membranes are equipped with a factory applied adhesive film. The membrane is rolled out and bonded directly to the substrate when the release liner is removed.

- No liquid adhesive on the building site
- Fast and easy installation

The self adhesive backing offers instant adhesion, making the installation very fast and efficient on most roof slopes.

Sika Adhered Roofing Experience



Sika Experience with Roofing Membranes

The first adhered Sika Roofing systems were introduced in the late 1960's and have since been proven roofing solutions in the building trade. Over the past decades Sika adhered systems have been successfully performing on numerous building types in most climate zones all over the globe.

- Long lasting waterproofing system
- Global solutions
- Detailed specification and design support
- Application training and on site support

Sika is one of the most experienced singly ply membrane producers with a track record of more than 50 years. With the **Sikaplan**[®] and **Sarnafil**[®] product lines, Sika Roofing offers market-orientated high-quality, single ply adhered roofing systems including the ancillary components.

- PVC and FPO single ply membranes
- Range of adhesives, cleaners and sealants
- Thermal insulation
- Prefabricated parts

Sika Adhesives

Sika develops and supplies bonding, sealing, damping and reinforcing solutions for construction, industry and automotive applications. We supply solutions for structural glazing, sandwich panel productions and many other application fields. This extensive know-how in adhesive technologies has resulted in a wide range of high performance adhesives covering all of the needs in adhered roofing.

- Contact adhesives for single ply membranes
- Single-component polyurethane (PU) membrane adhesives
- Single-component polyurethane (PU) insulation adhesives
- Water based adhesives
- VOC free hot-melt adhesives



New Constructions

Flat, pitched, domed, vaulted or other roof shapes – the **Sarnafil®** / **Sikaplan®** adhered roofing systems offer almost unlimited creative freedom to the specifiers. Sika adhered systems are a great solution in new constructions and offer many benefits.

- Freedom of design
- High aesthetic appearance
- Application on simple and complex roof shapes
- No membrane movement / flutter under wind load
- No visible fasteners
- No penetrations of the roof deck

A big range of available membrane colours and design profiles provide the specifiers with the opportunity to reproduce the appearance of traditional metal roofs or individual design needs.

Sika adhered systems are generally installed on public and residential buildings, including schools, offices, hotels, hospitals, apartments, sports centres or other leisure centres.

Refurbishment

The refurbishment of existing roofs is a growing need in most markets. By far the largest number of all roof reconstructions is the refurbishment of old bitumen roofs.

Sarnafil® / **Sikaplan®** adhered roofing systems are specially designed for roof refurbishment works, making them the No. 1 choice for the re-roofing of most bituminous roofs.

- Bitumen compatible membranes
- Membrane and insulation adhesives with excellent adhesion directly to bitumen
- No penetrations of the existing roof build up are required
- Very low noise emissions during installation
- High aesthetic appearance and visual improvement
- Many design possibilities with coloured membranes and profiles

These systems can be installed with or without additional thermal insulation as required.

For the selection of the right refurbishment system, a specific project survey and assessment has to be undertaken. Please contact the Technical Services Department of your local Sika company for assistance.

Solutions for Adhered Roofs: New Constructions

Fully Adhered Systems with Single Ply Membranes



Requirements

- Fully adhered lacquered felt-backed PVC membrane with extended guarantee
- Highest aesthetic appearance
- No penetration of the roof deck (when all roof build-up components are adhered)
- Special colours and design (décor profiles)
- Limited water underflow

Design / Build-up

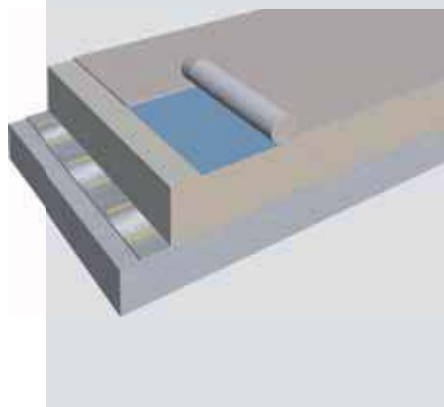
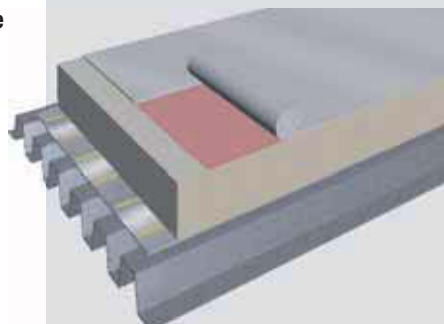
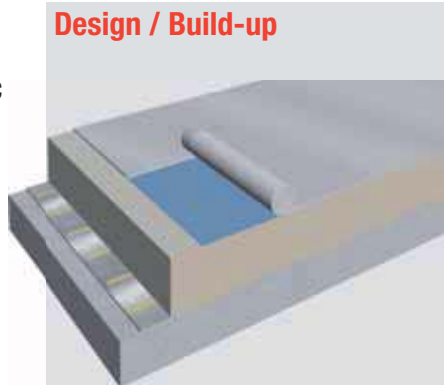

- Fully adhered lacquered PVC membrane with extended guarantee
- High aesthetic appearance
- Instant adhesion, convenient for application on steep roof slopes
- No penetration of the roof deck (when all roof build-up components are adhered)
- Special colours and design (décor profiles)
- Limited water underflow

- Fully adhered felt-backed FPO membrane with extended guarantee
- High aesthetic appearance
- High chemical resistance of the waterproofing membrane
- No penetration of the roof deck (when all roof build-up components are adhered)
- Special colours and design (décor profiles)
- Limited water underflow

Sika System

- **Sarnafil® G 410 EL Felt PVC** membrane fully adhered to the insulation with **Sarnacol® 2142S**
- PIR, EPS/XPS insulation bonded to the vapour control layer with **Sarnacol® 2162** or mechanically fastened to the substrate
- Self adhesive vapour control layer **Sarnavap® 5000E SA** or bitumen
- **Primer 600**, where required
- Concrete (or timber / steel) deck



- **Sarnafil® G 410 EL PVC** membrane fully adhered to the insulation with **Sarnacol® 2170**
- PIR insulation bonded to the vapour control layer with **Sarnacol® 2162** or mechanically fastened to the substrate
- Self adhesive vapour control layer **Sarnavap® 5000E SA** or bitumen
- **Primer 600**, where required
- Concrete (or timber / steel) deck



- **Sarnafil® TG 76 Felt FPO** membrane fully adhered to the insulation with **Sarnacol® 2142S**
- PIR, EPS/XPS insulation bonded to the vapour control layer with **Sarnacol® 2162** or mechanically fastened to the substrate
- Self adhesive vapour control layer **Sarnavap® 5000E SA** or bitumen
- **Primer 600**, where required
- Concrete (or timber / steel) deck



Partially Adhered and Self Adhered Systems with Single Ply Membranes



Requirements

- **Partially adhered standard felt-backed PVC membrane**
- Fast installation
- Low adhesive consumption
- No penetration of the roof deck (when all roof build-up components are adhered)
- Standard guarantee (from your local Sika organisation)

- **Partially adhered standard felt-backed PVC membrane on composite panel**
- Low adhesive consumption
- No penetration of the roof deck
- Standard guarantee (from your local Sika organisation)

- **Self-adhered PVC membrane**
- Easy and fast installation
- Instant adhesion, convenient for application on steep roof slopes
- No penetration of the roof deck
- Standard guarantee (from your local Sika organisation)
- Limited water underflow

Design / Build-up

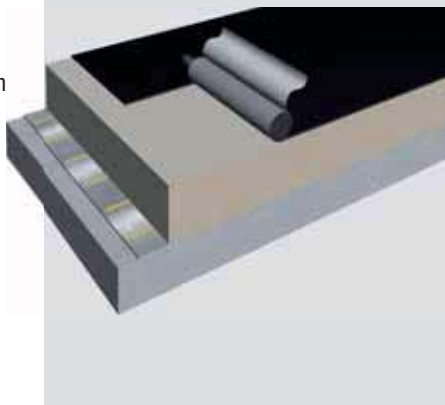
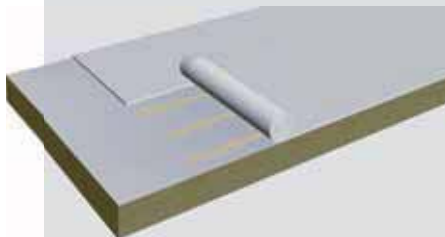
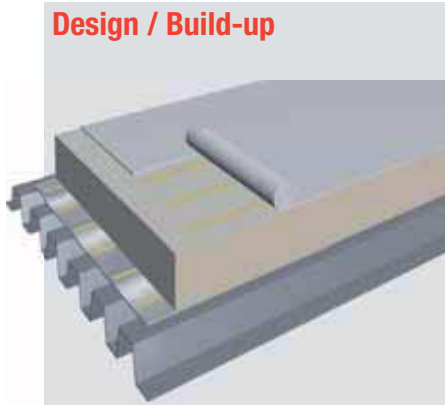

Sika System

- **Sikaplan® SGK** PVC membrane partially adhered to the insulation with **Sika-Trocal® C 300**
- PIR, EPS/XPS insulation bonded to the vapour control layer with **Sarnacol® 2162** or mechanically fastened to the substrate
- Self adhesive vapour control layer **Sarnavap® 5000E SA** or bitumen
- **Primer 600**, where required
- Steel (or timber / concrete) deck



- **Sikaplan® SGK** PVC membrane partially adhered to pre-fabricated panels with **Sika-Trocal® C 300**
- **Primer 600**, where required
- Composite or sandwich panels



- **Sikaplan® RV-s** self-adhered PVC membrane
- PIR insulation bonded to vapour control layer with **Sarnacol® 2162**
- Self adhesive vapour control layer **Sarnavap® 5000E SA** or bitumen
- **Primer 600**, where required
- Concrete (or timber / steel) deck



Solutions for Adhered Roofs: Refurbishment of Bitumen Adhered Systems without Additional Insulation



Requirements

- Fully adhered lacquered felt-backed PVC membrane with extended guarantee
- Special colours and design (décor profiles)
- No drilling into the roof deck and no penetrations
- Low noise emission during refurbishment
- Limited lateral water underflow

- Fully adhered felt-backed FPO membrane with extended guarantee
- High chemical resistance of the waterproofing membrane
- No drilling into the roof deck and no penetrations
- Low noise emission during refurbishment
- Limited lateral water underflow

- Self-adhered PVC membrane
- Easy and fast installation
- No drilling into the roof deck and no penetrations
- Low noise emission during refurbishment
- Limited water underflow

- Partially adhered standard felt-backed PVC membrane
- Fast installation
- Low adhesive consumption
- No drilling into the roof deck and no penetrations
- Low noise emission during refurbishment

Design / Build-up

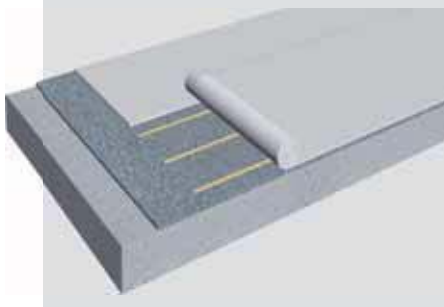
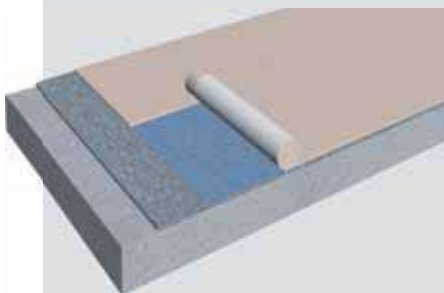

Sika System

- **Sarnafil® G 410 EL Felt** PVC membrane fully adhered to the bitumen substrate with **Sarnacol® 2142S** adhesive
- Existing roof build-up



- **Sarnafil® TG 76 EL Felt** FPO membrane fully adhered to the bitumen substrate with **Sarnacol® 2142S** adhesive
- Existing roof build-up



- **Sikaplan® RV-s** PVC membrane bonded directly to the bitumen substrate
- Surface preparation with **Primer 600**
- Existing roof build-up



- **Sikaplan® SGK** PVC membrane partially adhered to the bitumen substrate with **Sika-Trocral® C 300** adhesive
- Existing roof build-up



Roofs

Adhered Systems with Additional Insulation



Requirements

- Fully adhered lacquered felt-backed PVC membrane with extended guarantee
- Additional thermal insulation
- Special colours and design (décor profiles)
- No penetrations of the roof deck (when all roof build-up components are adhered)
- Low noise emission during refurbishment
- Limited water underflow

■ Fully adhered felt-backed FPO membrane with extended guarantee

- Additional thermal insulation
- High chemical resistance of the waterproofing membrane
- No penetrations of the roof deck (when all roof build-up components are adhered)
- Low noise emission during refurbishment
- Limited water underflow

■ Self-adhered PVC membrane

- Additional thermal insulation
- No penetrations of the roof deck (when all roof build-up components are adhered)
- Low noise emission during refurbishment
- Limited water underflow

■ Partially adhered standard felt-backed PVC membrane

- Additional insulation
- Low adhesive consumption
- No penetrations of the roof deck (when all roof build-up components are adhered)
- Low noise emission during refurbishment

Design / Build-up

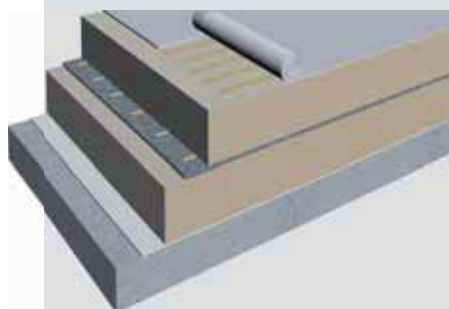
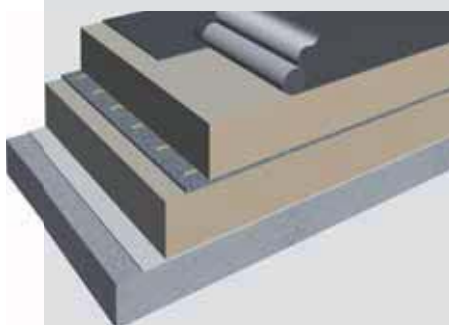
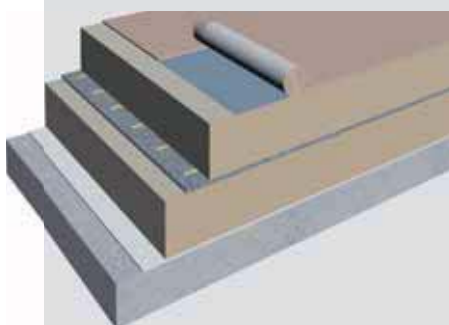
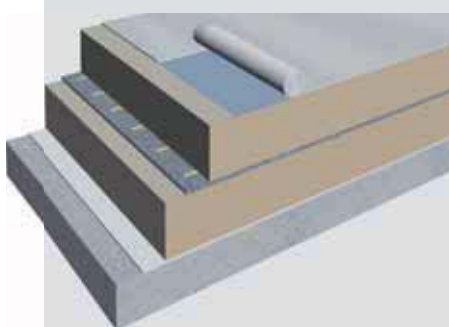

Sika System

- **Sarnafil® G 410 EL Felt** PVC membrane fully adhered to the insulation with **Sarnacol® 2142S** adhesive
- PIR, XPS/EPS insulation bonded to the bitumen with **Sarnacol® 2162** or mechanically fastened to the substrate
- Existing roof build-up



- **Sarnafil® TG 76 Felt** FPO membrane fully adhered to the insulation with **Sarnacol® 2142S** adhesive
- PIR, XPS/EPS insulation bonded to the bitumen with **Sarnacol® 2162** or mechanically fastened to the substrate
- Existing roof build-up



- **Sikaplan® RV-s** PVC membrane adhered to the PIR, XPS/EPS insulation
- PIR, XPS/EPS insulation bonded to the bitumen with **Sarnacol® 2162** or mechanically fastened to the substrate
- Existing roof build-up



- **Sikaplan® SGK** PVC membrane partially adhered to the insulation with **Sika-Trocal® C 300** adhesive
- PIR, XPS/EPS insulation bonded to the bitumen with **Sarnacol® 2162** or mechanically fastened to the substrate
- Existing roof build-up



Sika as Global Leader in Single Ply Membranes



PVC Roofing Membranes

Type

PVC membranes

Brand names

Sarnafil®, **Sikaplan®**

Advantages

- Established technology with the longest track record
- Availability of products for exposed roofing applications with high fire ratings / extended fire resistance
- Easy to repair
- Possibility of customized design solutions (colours, profiles, and roof graphics)
- Homogeneous hot air welded joints
- Easy to handle on site
- Suitable for use and exposure in different climatic conditions
- Fast installation independent of the weather
- Good vapour permeability
- Highly flexible
- Flame free installation
- Recyclable

FPO Roofing Membranes

Type

Polyolefin membranes

Brand name

Sarnafil®

Advantages

- High chemical resistance
- Suitability for direct application on such substrates, as bitumen, EPS and XPS insulation (polystyrenes)
- Availability of products for exposed roofing applications with high fire ratings / extended fire resistance
- Plasticizer free (no migration / contamination or leaching)
- Long life expectancy
- Easy to repair
- Homogeneous hot air welded joints
- Easy to handle on site
- Suitable for use and exposure in different climatic conditions
- Fast installation independent of the weather
- Outstanding ecological profile
- Flame free installation
- Recyclable
- Proven track record for over 20 years

Adhesive Competence of Sika

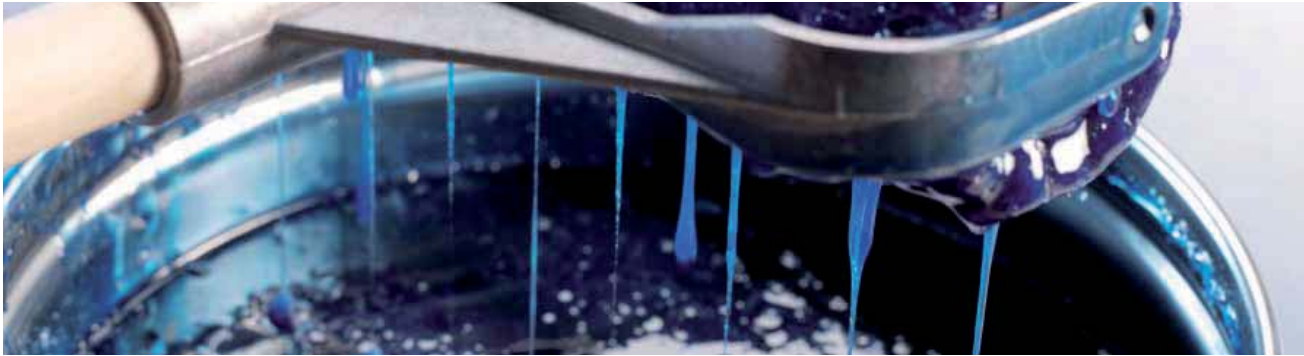

Contact Adhesives

High quality adhesives designed for bonding membranes to different substrates on roof areas or at upstands, flashings and perimeter termination areas.

- Excellent adhesion properties
- Full compatibility with Sika membranes
- Wide range of adhesives suitable for all different substrates
- Immediate adhesion
- Single component products in the range

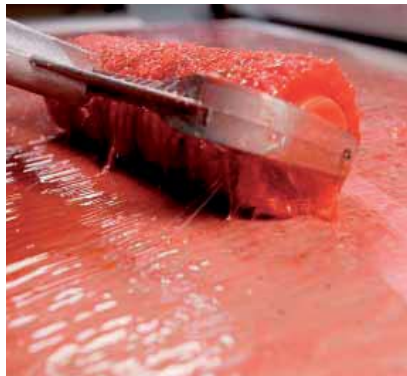

Sika products:

- **Sarnacol® 2105** – Water based and VOC compliant adhesive for **Sarnafil® G/S** and **Sikaplan®** PVC membranes
- **Sarnacol® 2170** – adhesive for **Sarnafil® G/S** PVC membranes
- **Sarnacol® T 660** – adhesive for bonding **Sarnafil® TG 66** membranes to flashings
- **Sika-Trocal® C 733** – adhesive for bonding **Sikaplan®** PVC membranes to flashings

PU-Based Membrane Adhesives

These are used in fully and partially adhered roofing systems to bond the membranes to various substrates

- Excellent adhesion properties also directly on bitumen
- Full compatibility with Sika felt-backed membranes
- Compatible with EPS/XPS insulation
- Bonds very well in humid conditions
- Low solvent content
- Single component products for easy use



Sika products:

- **Sarnacol® 2142S** – adhesive for bonding **Sarnafil® G 410 Felt** and **Sarnafil® TG 76 Felt** membranes to roof substrates
- **Sika-Trocal® C 300** – adhesive for bonding **Sikaplan® SGK** membranes to roof substrates

Insulation Adhesives

Specially designed adhesives for bonding different types of thermal insulation to the vapour control layer or to the roof deck.

- Excellent adhesion properties also directly on bitumen
- Suitable for a wide range of thermal insulation types and different substrates
- Bonds very well in humid conditions
- Has a limited foaming effect allowing improved adhesion on rough roof surfaces
- Low solvent content
- Single component products in the range



Sika products:

- **Sarnacol® 2162** – Single component and slightly foaming insulation adhesive
- **Sikalastic® Coldstick** – Two component insulation adhesive

Sika Adhered Roofing Products



Systems





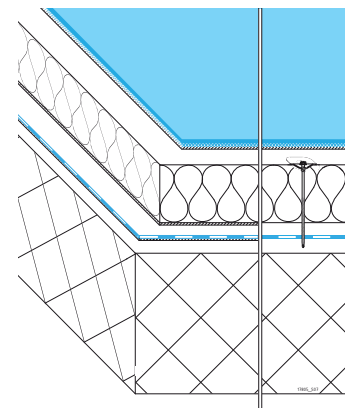

System	Membrane	Material	Thickness	Adhesive	Bonding Method	Adhesive Consumption
Fully Adhered	Sarnafil® G 410 EL	PVC	1.2 – 2.0 mm	Sarnacol® 2105	Contact	300 – 500 g/m ²
				Sarnacol® 2121	Wet – bed	500 – 800 g/m ²
				Sarnacol® 2170	Contact	400 – 800 g/m ²
	Sarnafil® G 410 EL Felt	PVC	1.2 – 1.8 mm	Sarnacol® 2105	Wet – bed	300 – 600 g/m ²
				Sarnacol® 2121	Wet – bed	500 – 800 g/m ²
				Sarnacol® 2142S	Wet – bed	300 – 500 g/m ²
	Sarnacol® 2170	Wet – Bed	300 – 500 g/m ²			
	Sarnafil® TG 76 Felt	FPO	1.2 – 2.0 mm	Sarnacol® 2142S	Wet – bed	300 – 500 g/m ²
Partially Adhered	Sikaplan® SGK	PVC	1.2 – 1.5 mm	Sika-Trocal® C 300	Wet – bed	200 – 300 g/m ²
Self Adhered	Sikaplan® RV-s	PVC	2.3 mm	–	Self adhering	–

Roof Build-up

	Adhered Roof Build-up	Composite Roof Build-up
Main Properties	<ul style="list-style-type: none"> ■ Thermal insulation adhered to vapour control layer or roof deck ■ Ideal where drilling noise or penetrations have to be avoided 	<ul style="list-style-type: none"> ■ Thermal insulation mechanically fastened to roof deck
Membrane	Adhered	Adhered
Thermal Insulation	Adhered	Mechanically Fastened
Vapour Control Layer	Sarnavap® 5000E SA Bituminous vapour control layer	Sarnavap® 500E Sarnavap® 1000E Sarnavap® 2000E Sarnavap® 3000M Sarnavap® 5000E SA FR
Roof Deck	Concrete, steel decks (min. 50% bond area), timber, other closed decks	Timber, steel decks, others



Application Overview of Sika Roofing Adhesives

	Sarnacol® 2105	Sarnacol® 2121	Sarnacol® 2142S	Sarnacol® 2170	Sarnacol® 2162	Sika-Trocal® C 300
						
Main Properties	<ul style="list-style-type: none"> ■ VOC free ■ Contact and wet-bed adhesive 	<ul style="list-style-type: none"> ■ Water and synthetic resin based dispersion ■ Wet-bed adhesive 	<ul style="list-style-type: none"> ■ 1-Component Polyurethane adhesive ■ Moisture curing ■ Wet-bed adhesive 	<ul style="list-style-type: none"> ■ Rubber based solvent containing adhesive ■ Contact and wet-bed adhesive 	<ul style="list-style-type: none"> ■ 1-Component Polyurethane adhesive ■ Moisture curing ■ Insulation adhesive 	<ul style="list-style-type: none"> ■ 1-Component Polyurethane adhesive ■ Moisture curing ■ Wet-bed adhesive
Fully Adhered	✓	✓	✓	✓		
Partially Adhered					✓	✓
Membrane Adhesive	✓	✓	✓	✓		✓
Insulation Adhesive					✓	
Concrete	✓	✓	✓	✓	✓ ⁵⁾	✓
Metal / Steel	✓			✓	✓	✓
Timber Products	✓	✓	✓	✓	✓ ⁵⁾	✓
Bitumen¹⁾			✓		✓	✓
EPS/XPS²⁾	✓		✓		✓	✓
PIR/PUR³⁾	✓	✓	✓	✓	✓	✓
Mineral Fibre⁴⁾	✓		✓	✓	✓	✓
Hard / Soft PVC				✓		
Application	Roller / Brush	Roller / Brush / Spatula	Roller / Brush / Spatula	Roller / Brush	Out of tin	Out of tin / Cart
Flat Roofs	✓	✓	✓	✓	✓	✓
Sloped / Curved Roofs	✓		✓ ⁶⁾	✓	✓ ⁶⁾	✓ ⁶⁾
Detailing/Upstands	✓			✓		

- Note:** 1) Slated, mineralized or aged bitumen. Talcum coated bitumen not recommended
2) EPS / XPS: Block cut surfaces, density $\geq 25 \text{ kg/m}^3$ and compressive strength $\geq 120 \text{ kPa}$
3) PIR/PUR: With glass tissue facing, suitable for Sika adhered systems
4) Mineral fibre: With sufficient compressive strength and suitable facing for Sika adhered systems
5) Pre-treat with Primer 600
6) At roof slopes greater than 10° , additional mechanical securing is needed till adhesive has set

Installing Adhered Roofs



Preparation

Working with Adhesives

When working with adhesives always follow the general rules:

- Store in dry conditions at temperatures between +5°C and +30°C in their original container
- Stir adhesive thoroughly before use
- Only apply at temperatures between +5°C and +40°C and in dry weather conditions
- Consult the Product Data Sheet and Material Safety Data Sheet

Substrate Quality

In adhered roofs, the wind loads acting on the membrane are transmitted over the adhesive film into the substrate. The following basic rules are therefore crucial:

- Wind load resistance is directly dependent on the quality of substrate and adhesion
- Establish wind uplift with project specific wind load calculations
- Ensure that all layers under the roofing membrane offer sufficient strength to absorb the occurring wind loads and are permanently secure
- The inner strength of the thermal insulation has to be strong enough to absorb the wind loads

Substrate Preparation

- Clean substrate with a broom
- The substrate must be dry
- Remove any oil or grease
- Cut open and remove any loose section of the substrate e.g. on refurbishment projects
- Remove any burrs or sharp objects
- Clean with a suitable cleaner if necessary

Thermal Insulation

Basic Principles

When using solvent based membrane adhesives like **Sarnacol® 2170**, it's crucial to ensure that the thermal insulation is solvent resistant. In many cases, the insulation suppliers demand additional taping of the board joints with aluminium faced tape.

Mechanically Fastened Insulation

If the thermal insulation is mechanically fastened to the roof deck (composite roof build-up), the number of insulation fasteners is determined with project specific wind load calculations.

Adhered Insulation

In the case of an adhered roof build-up the thermal insulation is adhered to the bearing structure, existing roof, bituminous vapour control layer or **Sarnavap® 5000E SA**. On critical substrates and existing roofing materials, the adhesion of **Sarnacol® 2162** always has to be tested prior to the application and may require **Primer 600**. Follow the general application procedure:

- Make sure the substrate is solid, clean and free of oil and grease.
- Apply at least 4 continuous beads of adhesive per linear metre with a width of 10 – 15 mm (25 – 75 g/m)
- Lay and press the insulation board into the wet adhesive beads.
- In high wind load areas, the number of beads has to be verified with project specific wind load calculations
- Do not apply more adhesive than can be covered in 5 minutes

Adhesive and Membrane

Contact Adhering

The method of contact adhering can only be used with bare membrane types i.e. non-felt backed membranes.

- Adhesive is applied to both mating surfaces, the membrane and substrate
- Instant adhesion when the two surfaces come into contact
- No adjustment after adhering possible
- Press down membrane using a heavy roller (approximately 50 kg)

Wet – bed Adhering

With the method of wet-bed adhering, the membrane is rolled into the wet adhesive bed.

- In some cases a priming coat of adhesive has to be applied first
- Adhesive is applied to the substrate
- Immediately roll out the membrane over the wet adhesive bed
- In fully adhered systems press down membrane using a heavy roller (approximately 50 kg)
- On roof slopes greater than 10°, the membrane must be mechanically secured until the adhesive has set

Self Adhering

Self adhering membranes have a factory manufactured adhesive film on the membrane.

- **Primer 600** might be necessary on critical substrates
- Instant adhesion, no adjustments possible after application



Welding

Basic Principles

The seams of **Sikaplan®** and **Sarnafil®** membranes are always hot-air welded. To ensure optimum seam quality, the following actions are required:

- Always conduct test welds under matching external weather conditions, before starting work
- The weld areas must be dry and clean, wash with water or use an appropriate cleaner if necessary
- When using solvent containing adhesives (**Sarnacol® 2170**), weld the membranes immediately or later than 7 hours after the adhesive has been applied
- Mechanically check the seams, to ensure the integrity and fullness of the weld



Manual Hot-Air Welding

- Handheld welder
- Suitable for smaller, complicated roofs
- Used for detailing work

Automatic Hot-Air Welding

- Technically advanced automatic hot-air welding machines
- Efficient and safe welding
- Reliable, high quality seams
- Suitable for large roof areas



Perimeter Securement

Basic Principles

In all adhered systems, mechanical perimeter fastenings (peelstops) must be applied to prevent peeling of the membrane from the substrate.

- Around the entire roof edge
- At all upstands
- At all terminations
- At all roof penetrations

If it's not possible to drive fasteners into the roof deck, the peelstop must be fastened into the base of upstands using a Sarnabar Peelstop.

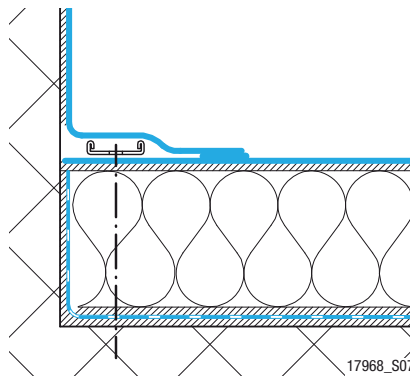

Maintenance

Basic Principles

Regular maintenance of the roof saves costs in the long run and helps keep the building in top condition. Periodic inspections can be conducted by a qualified caretaker or owner; repairs should be done only by roofing professionals. Periodic inspections should include the following:

- Inspection of the roof from indoors
- Rooftop inspection of the surface
- Checking connections and flashings
- Checking drainage, normal maintenance
- Checking the integrity of lightning protection system



Ancillary Materials and Accessories



Thermal Insulation

The Sika Roofing range incorporates the most efficient types of thermal insulation available on the market and offers suitable types for adhered roofing applications.

PIR/PUR

Thermal insulation boards produced from rigid PU foam with an isocyanurate catalyst. This is a universal and efficient solution and is the most suitable insulation type for adhered systems.

- **SarnaTherm® PIR**
- **Sikatherm®**
- **Sarnapur®**

EPS

Thermal insulation boards produced from expanded polystyrene granules. It is one of the most efficient solutions of thermal insulation. Sika offers a range of suitable EPS for adhered systems.

- **SarnaTherm® EPS**
- **S-Therm EPS**



Application Tools

Efficient and reliable installation is ensured by state-of-the-art technology in tools and equipment. Sika offers specially designed application tools to ensure optimal quality.

- Spray Tool for the **Sarnacol® T 770** solvent free hot – melt adhesive used for bonding upstands with **Sarnafil® T** membranes
- Nylon rollers for adhesive application
- Dispenser Cart for controlled and continuous strips of adhesive
- Heat Gun for executing details or to activate evaporated adhesive
- Automatic welding machines
- Hand-held welding machines



Cleaners, Sealants, Preparation Agents

All the ancillary products for detailing, cleaning, seam sealing, seam preparation and more are specially designed for use in roofing. Together with the right tools, these should always be on site to ensure good workmanship.

- Contact adhesives and hot-melt adhesives for the execution of flashings
- Seam cleaners and general purpose cleaners
- Seam preparation agents
- Sealants for details at connections and terminations
- Primers





Vapour Control Layers

Vapour control layers are integral components of Sika Roofing systems, allowing airtight, vapour-controlled seals at joints and terminations. The **Sarnavap**® vapour control layers are based on polyethylene or polymer bitumen with aluminium facing and are available in various sizes and types.

- Range of diffusion resistances (600'000 to 3'000'000 μ)
- **Sarnavap® 3000M** has a foam backing for the installation on rough substrates
- **Sarnavap® 5000E SA** is a self-adhesive vapour barrier made of polymer bitumen and aluminium foil facing

The vapour control layers come in rolls and have the following properties:

- Stay flexible at low temperatures
- Resistant to chemicals
- Long life-span
- Non-decaying
- Constant vapour diffusion resistance

Separation / Protection and Levelling Layers

If separation from non-compatible substrates or protective and levelling layers are required, **S-Felt** synthetic fibre fleeces are used. These products have various weights and properties and come in rolls.

- Based on polypropylene or polyester
- With PE coating on one side (**S-Felt GK**)
- UV resistant (**S-Felt T 300**)
- Resistant to various chemicals and materials
- Resistant to heat (+60 °C) and frost (-30 °C)
- Non-decaying

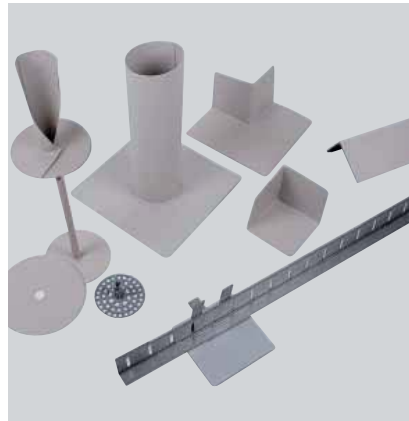

Prefabricated Parts

Sikaplan® and **Sarnafil**® prefabricated parts are made out of a polyvinylchloride (PVC) or polyolefin (FPO) and are designed exclusively as components of the Sika Roofing system.

- Easy and rapid installation
- Neat and reliable details
- Good resistance to weather, UV-radiation and stress cracking
- Guarantee system compatibility
- Secure welding to membranes



Décor Profiles and Batten Profiles

Extruded profiles using the same high quality of materials used for our membranes, offer excellent styling and design possibilities. Particularly for sloped, highly visible roofs, décor profiles are the way to break up large areas, emphasize forms and give the roof a special look.

- Use Décor and Batten Profiles to imitate the appearance of metal roofs
- Traditional lead batten roll, copper and modern standing seam roofs can all be realistically reproduced
- Décor Profiles are available in a wide range of colours



Services and Support in Roofing



Sika is a proven and reliable partner to the whole building and construction industry. Worldwide we provide our customers far more than just the best 'state of the art' and technically proven waterproofing materials. We also assist and add value for our customers, by providing many more support services for our products and their installation.

Wind Load Calculations

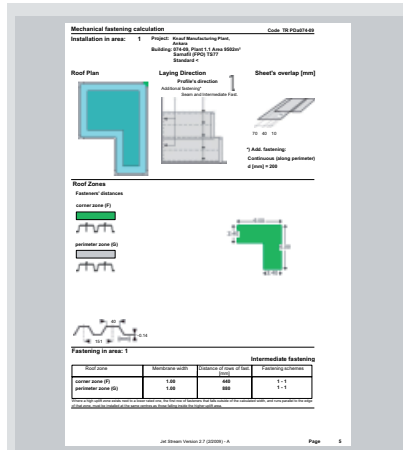

Our specially developed "Jet Stream" computer software is used to design mechanical fixing systems for our clients and their designers. This 'state of the art' software now includes most national standards and regulations. It is an extremely efficient and practical tool for producing the most effective fixing solutions including a detailed layout and Method Statements, with all of the necessary information for contractors to estimate and carry out the works on site. It can also contribute to significant savings in the roof build-up and your overall construction costs.

Roof Survey and Assessments for Refurbishment Specifications and Details



Sika roofing engineers can advise and assist with the production of the necessary survey and assessment work required for roof refurbishment projects. This provides customized roof re-waterproofing specifications which also include detailing solutions and Method Statements etc.

Sika Installation Equipment



Equipment which is specifically developed for installation of Sika roofing systems includes:

- Welding machines
- Sikalastic application tools





Sika provides an extensive support and service for each of our roofing product lines. This is tailored to each system and in each product line it covers all stages in the design, planning and execution of membrane roof waterproofing, from the roof condition survey or requirements analysis, through full documentation, to expert training and support on site throughout the installation – anywhere in the world.

CAD Details, Technical Documentation

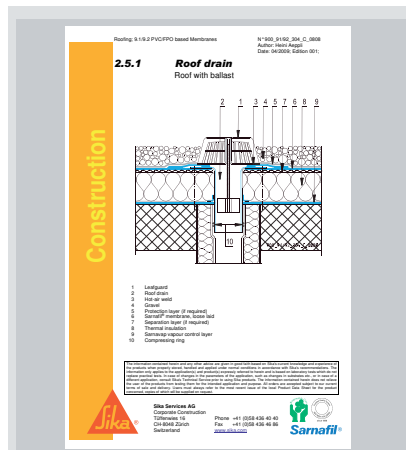

A wide range of CAD drawings, installation guidelines, Method Statements, Product Data Sheets and considerable additional technical documentation, approvals and certificates are available for Sika roofing membranes and systems.

Guarantees



Guarantees are provided to fulfil our different client's needs and demands. Comprehensive warranties for watertightness and compatibility with other building materials are issued individually for each project in accordance with all relevant local regulations.

Technical and Product Application Training



The many different applications for Sika waterproofing systems require different installation techniques and detailing solutions. The theoretical and practical, technical and application training courses run by Sika roofing engineers also help to ensure the security and durability of the installation.

Sika Roofing Capability – Online Industrial Building Selection at www.sika.com



Exposed Roofs



Gravel Ballasted Roofs



Green Roofs

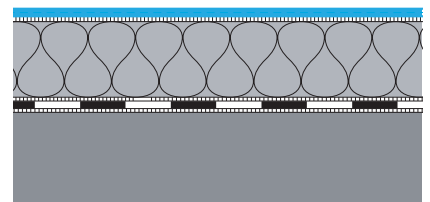
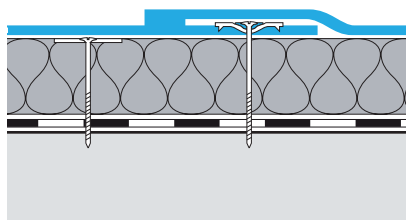
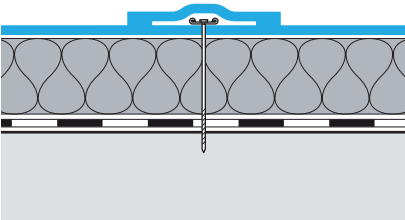
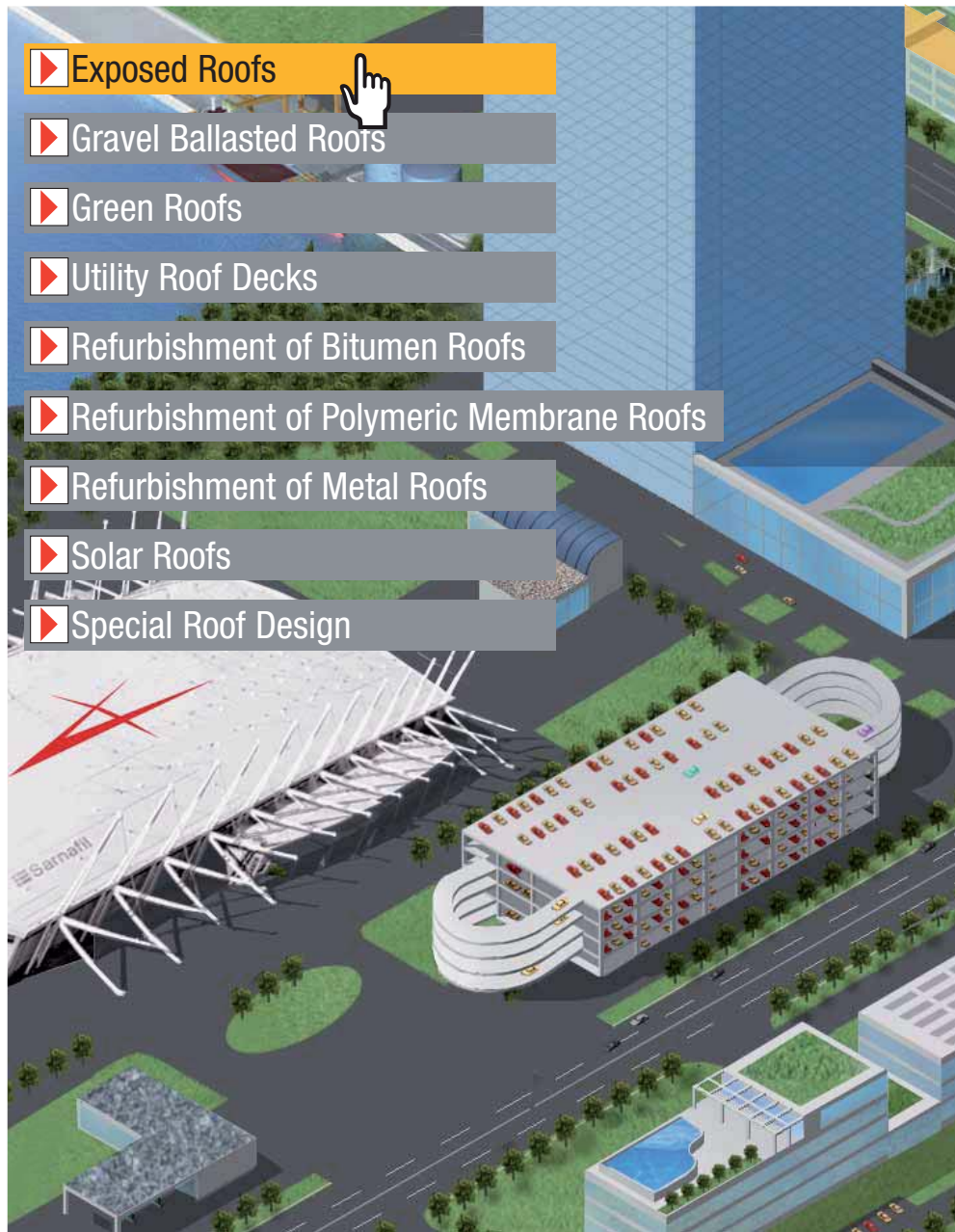

Exposed Roof

ction Guide



Utility Roof Decks



Solar Roofs



Special Roof Design

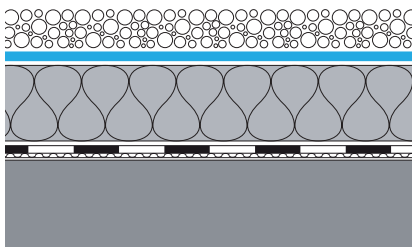

Gravel Ballasted Roof

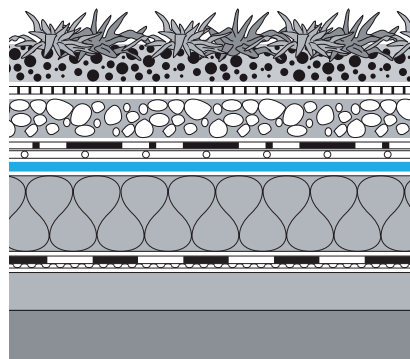

Green Roof

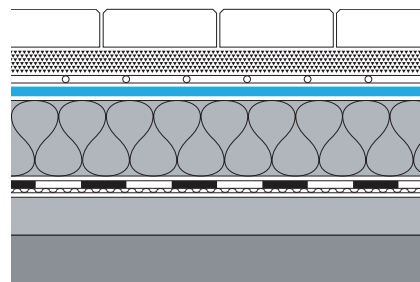

Utility Roof Deck

Sika Adhered Roofs: New Constructions Case Studies



IWM American Air Museum Duxford, England

The Project

- New construction of the museum
- Curved roof geometry with visible roof area
- Architect: Foster Associates
- Roof size: 6'500 m²

The Sika Solution

- Fully adhered **Sarnafil® G 410 – 12 EL Felt** membrane
- Adhered with **Sarnacol® 2170** adhesive



Oak Spinney Leicester, England

The Project

- New construction of administrative building
- Highly visible sloped roof
- Roof size: 1'000 m²

The Sika Solution

- Fully adhered **Sarnafil® G 410 – 12 EL Felt** membrane in Lead Grey
- Adhered with **Sarnacol® 2170** adhesive
- Décor Profiles to reproduce the appearance of a standing seam metal roof



The Saffire Resort Coles Bay, Tasmania

The Project

- New construction of luxury resort
- Sloped and 3D curved roofs
- Morris Nunn Architects

The Sika Solution

- Fully adhered **Sarnafil® G 410 – 15 L Felt** membrane in Blue Grey
- Adhered with **Sarnacol® 2142S** adhesive



Cold Store SamSung Tesco Korea

The Project

- New construction of the Tesco cold store building
- Flat roof build-up with composite roof panels
- Roof size: 20'000 m²

The Sika Solution

- Partially adhered systems with **Sikaplan® SGK 1.5** membrane
- Adhered with **Sika-Trocal® C 300** adhesive
- Installation with application cart

Sika Adhered Roofs: Refurbishment Case Studies



Harefield Hospital Harefield, England

The Project

- Refurbishment of the asphalt roof on the hospital building
- Hospital hat to stay in use during refurbishment
- Upgrading of the thermal insulation required
- Roof size: 4'500 m²

The Sika Solution

- Additional PIR insulation bonded with **Sarnacol® 2162** adhesive
- Fully adhered **Sarnafil® G 410 – 12 EL Felt** membrane
- Adhered with **Sarnacol® 2170** adhesive



Solihull Girls School Sixth Form College Solihull, England

The Project

- Refurbishment of the school building
- Construction works during school hours
- Very steep roof area with many details and highly visible roof area
- Roof size: 1'500 m²

The Sika Solution

- Fully adhered **Sarnafil® G 410 – 12 EL Felt** membrane in Lead Grey
- Adhered with **Sarnacol® 2170** adhesive
- Décor Profiles to reproduce the appearance of a standing seam metal roof



Morgan Street Office Building Wagga Wagga NSW, Australia

The Project

- Refurbishment of public services office building
- Office buildings in use during refurbishment
- Roof size: 1'100 m²

The Sika Solution

- Fully adhered **Sarnafil® G 410 – 15 L Felt** membrane
- Adhered with **Sarnacol® 2142S** adhesive



Stadttheater Mainz Mainz, Germany

The Project

- Refurbishment of theatre roof
- Installation on existing bituminous roof
- Roof size: 1'000 m²

The Sika Solution

- Self adhered **Sikaplan® RV-s** membrane
- Pre-treatment of existing bitumen with **Primer 600**

Performance and Installation Related Requirements



UV-Resistance

Light, especially energy-rich ultraviolet light, has an ageing effect on roof membranes that can eventually result in surface cracking and degradation. Sika roofing membranes for exposed roofs are all more than sufficiently UV stabilized against this to perform for the long term, even in extreme climates and locations with high UV light exposure.



High Fire Resistance

Fire resistance requirements can be very individual and dependent on the type of construction and use of the building. If the roofing membrane is the top roof surface, then the membrane material must generally be classified as self-extinguishing. Sika roofing materials are all designed to comply with this and all relevant international and local building regulations in terms of fire.



Compatibility to Bitumen

As bitumen has been used as a traditional roofing material for many years, it is often still present on existing roofs to be refurbished or upgraded in terms of waterproofing, fire or insulation. For a fast and secure solution bitumen compatibility is a major requirement. Sika provides systems which are bitumen-resistant and can be used in almost any refurbishment situation.



Resistance to Cold

The weather around the world provides different climatic conditions in which roofing systems have to perform and resistance to minus temperatures is one of the main requirements here. All membranes from Sika stay flexible in cold within their stated performance limits. Some Sika roofing systems have the advantage that they can be installed at temperatures below zero.



Thermal Shock Resistance

Sika roof waterproofing membranes and all of the ancillary roofing products are specially designed to withstand sudden changes of temperature and weather conditions. They will not be damaged by extended or sudden thermal changes in cold, heat, snow, hail, rain, etc.



Slip Resistance

The Sika roofing product range includes sheet membranes with embossed surfaces to provide slip resistance. Different degrees of slip resistance can be also achieved with Sika liquid applied membranes by broadcasting with selected grades of quartz sand.



Root Resistant

Membranes used under ballast must also withstand penetration from the roots of plants. Roof gardens and other green roofs obviously have a particular requirement for this, not only from the membrane, but also at their welded seams, connections and terminations. Sika single ply and liquid applied membranes for ballasted roof systems all resist root penetration and are treated to be resistant against micro-organisms, or they are inherent by fully resistant.



Resistance to Pedestrian and Light Wheeled Traffic

Increasingly, roofing systems are being used for areas exposed to pedestrian and vehicular traffic, i.e. on roof terraces or car parking areas. If the roofing membrane is the top surface for traffic, it must withstand this abrasion and wear without additional protection. It also has to be slip-resistant and may need different colours for line marking etc. Sika liquid applied membrane systems provide full service trafficability for pedestrians and / or vehicles as required.



Fast Installation

Installation time is always an important issue and cost factor for roofing systems. Sika has developed many special roofing systems and ancillary products which allow extremely rapid and cost effective installation.



Mechanical fastenings and fixings

If the membrane is installed as the top layer of the roof, wind uplift will occur through wind suction and pressure. The membrane must therefore be restrained against wind uplift and the most cost effective method of doing this is by mechanical fastening into the support structure. Sika systems are designed to withstand wind loads using the most efficient fixings.



No Penetrations into the Deck

A mechanical fastening system may not be possible due to unacceptable drilling noise for the fixings, contamination through the deck, or due to the structural design itself. All of these difficulties and their potential costs can be overcome by using Sika adhered, ballasted or liquid applied membrane systems.



Loose Laid Build-up

Loose laying of the flexible membrane and its ancillary materials is the main method established to build-up a roof deck and waterproofing system. It allows free air flow to ventilate the thermal insulation and it also helps to compensate for the structure's movement. The membrane must then be mechanically fixed or ballasted for restraint against wind uplift.



Partially Adhered to the Substrate

If the membrane is to be used in an exposed situation, but mechanical fixing is not desirable for technical or other reasons, all layers of the system build-up must be bonded to the substrate below. In Sika partially adhered systems the liquid adhesive is applied on the substrate in beads or strips. This provides fast cost effective installation with low adhesive consumption.



Fully Adhered to the Substrate

Superior aesthetic appearance, regardless of the roof shape, or with no penetration of the roof deck, is often a requirement for both new and refurbishment projects. With Sika fully adhered systems the membrane is fully bonded to the substrate, therefore it can meet these high aesthetic and performance requirements reliably and with low maintenance costs.



Highest Aesthetic Appearance

Sometimes roofing materials not only have an important waterproofing function, but they must also meet high design and architectural requirements. Sika has developed several advanced systems suitable for installation over complex roof shapes with good looking top surfaces, i.e. including smooth surfaces, standing seam metal roof imitation and other special profiles, etc.



Wide Colour Range

Sika membranes are supplied in several standard colours, some in an extensive range. Special colours can also be made to order or colour matched to a client's requirements.



Seamless Waterproofing

The Sika liquid applied membranes provide seamless waterproofing over the entire roof surface. In addition to technical advantages, it can also create an excellent visual appearance.



Crack Bridging Ability

The Sika liquid applied membranes in particular can provide outstanding crack-bridging properties, with high flexibility and elasticity – even at low temperatures



1-C Single Component Products

1-C Sika liquid applied membranes are probably the easiest to install. They are applied 'direct from the can' and do not require mixing with other components.



Good Vapour Permeability

Sika has developed membranes which are waterproof, but with excellent vapour diffusion properties. This allows any moisture in the structure below to evaporate.



Easy Application by Brush or Roller

Sika liquid applied membranes can be applied by brush and roller. This application is easy and does not require investment in expensive application equipment.

Sika Full Range Solutions for Construction

Concrete Production



Sika® ViscoCrete®
Sika® Retarder®
Sika® SikaAer®

Waterproofing



Sikaplan®, **Sikalastic®**
Sika® & Tricosal® Waterstops
Sika® Injection Systems

Flooring



Sikafloor®
SikaBond®

Corrosion and Fire Protection



SikaCor®
Sika® Unitherm®

Concrete Repair and Protection



Sika® MonoTop®
Sikagard®
Sikadur®

Structural Strengthening



Sika® CarboDur®
SikaWrap®
Sikadur®

Joint Sealing



Sikaflex®
Sikasil®

Grouting



Sikadur®
SikaGrout®

Roofing



Sarnafil®
Sikaplan®
SikaRoof® MTC®

Also Available from Sika



Sika Services AG
 Business Unit Contractors
 Industriestrasse 26
 6060 Sarnen / Switzerland
 Phone +41 58 436 79 66
 Fax +41 58 436 78 99
 www.sika.com

Our most current General Sales Conditions shall apply.
 Please consult the Product Data Sheet prior to any use and processing.

